



Disegnato da Federica Biasi, Noa è un divano componibile formato da diversi elementi con cui progettare configurazioni lineari o a L. La base, sospesa sul particolare piedino in metallo, accoglie gli elementi imbottiti, con o senza schienale, ma anche piani in materiali preziosi come il legno o il marmo che fungono da tavolino. Essenziale e confortevole, Noa si personalizza in base a spazi, gusti ed esigenze.

Designed by Federica Biasi, Noa is a modular sofa comprising various sections that can be put together to create straight or L-shaped configurations. The base, seemingly floating on the distinctive metal foot, accommodates the upholstered sections - with or without backs - as well as shelves in high-end materials, like wood or marble, which serve as side tables. Pared back and comfortable, Noa can be customized to suit individual spaces, tastes and requirements.

Divano NOA / NOA sofa



RIVESTIMENTO COVERS

Rivestimento completamente sfoderabile in tessuto, in pelle è fisso.

La base del divano è rinforzata con un telaio perimetrale H. 5 cm e con un piedino centrale in metallo brunito sempre in dotazione.

Fully removable fabric covers, leather version has fixed covers.

The base of the sofa is reinforced with a 5 cm-high frame around the outside and always comes with a central metal foot in the bronze finish.

MODULARITÀ MODULE SIZES

Vista laterale divani Sofa side view

Con bracciolo
With arm

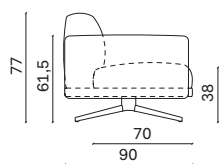

Senza bracciolo
Without arm

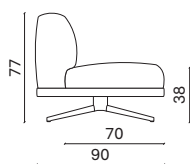

Senza schienale
Backless

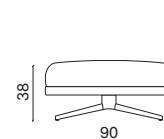

Vista frontale Front view

Divano
Sofa

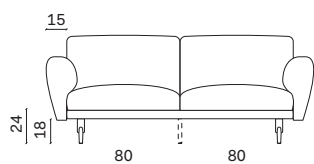

Centrale
Central

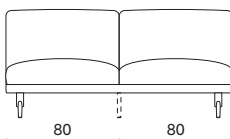

Penisola laterale
Side chaise longue

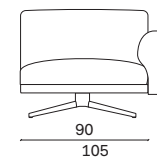

Divano con 2 schienali e 3 sedute
Sofa with 2 backs and 3 seats

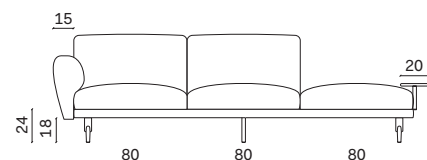

Divano con 2 schienali, 2 sedute e 1 piano legno/marmo/light stone
Sofa with 2 backs, 2 seats and 1 wood/marble/light stone shelf

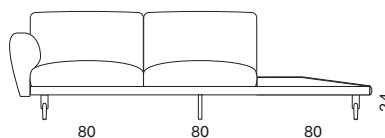

Gambe Legs

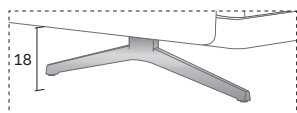

Divano NOA / NOA sofa

ELEMENTI FISSI FIXED UNITS

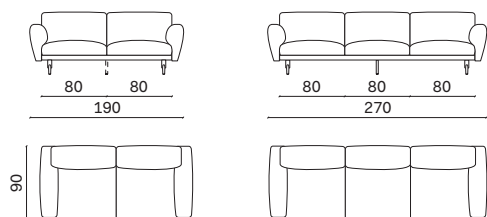

ELEMENTI LATERALI E PENISOLE SX - DX LH - RH SIDE SECTIONS AND CHAISE LONGUES

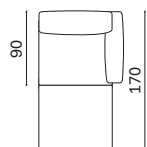
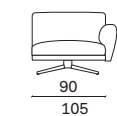
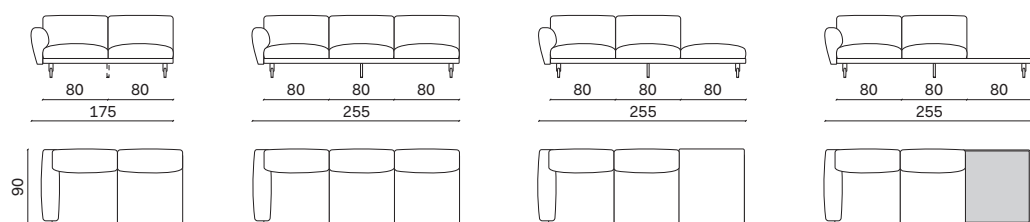

Con seduta a tutta
profondità.
With full-depth seat.

Con piano in legno,
marmo, pietra lavica o
light stone.
*With wood, marble
shelf, lava stone or
light stone.*

ELEMENTI E PENISOLE CENTRALI CENTRAL SECTIONS AND CHAISE LONGUES

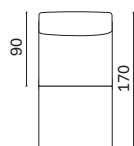
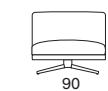
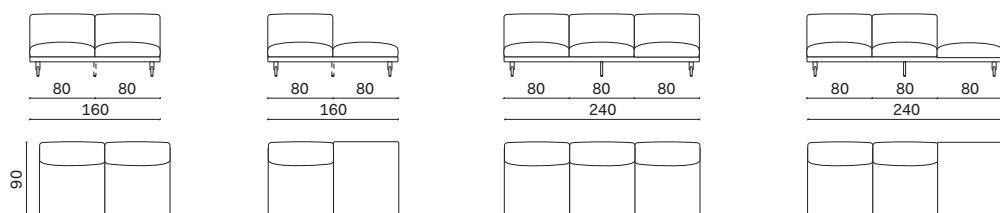

Divano NOA / NOA sofa

ELEMENTI ANGOLO SX - DX LH - RH CORNER SECTIONS

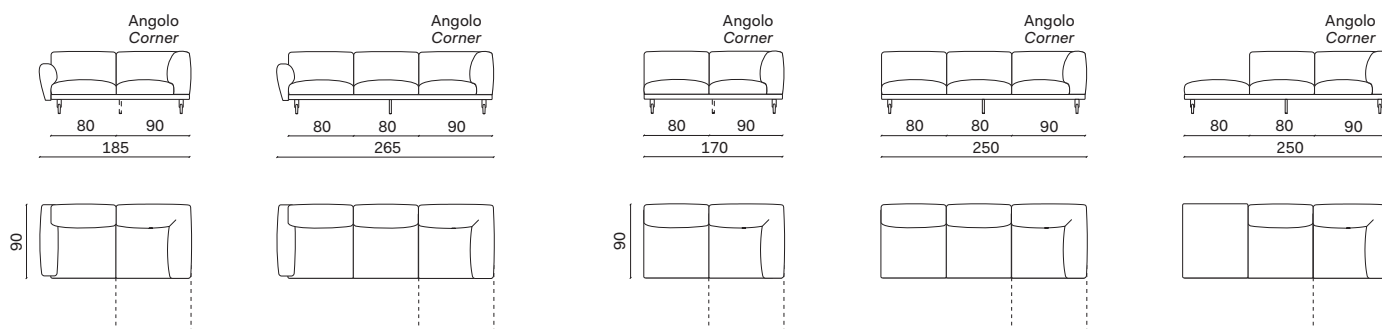

ACCESSORI ACCESSORIES

Tavolino Sofa table

Larghezza Width	Profondità Depth	Altezza Height	Peso Weight
20 cm	30 cm	1,8 cm	1,5 kg

Completo di struttura di appoggio alla base del divano H. 19 cm in metallo verniciato brunito. Per elementi senza bracciolo o schienale posizionabile esternamente e centrato rispetto alla seduta. Per elementi con bracciolo o schienale posizionabile tra 2 sedute.

Complete with 19 cm-high metal support sitting on the base of the sofa painted in bronze finish. For sections with no arm or back, it can be positioned on the outside, midway along the side of the seat. For sections with an arm or back, it can be positioned between 2 seats.

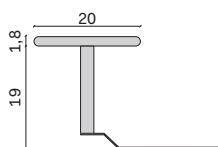
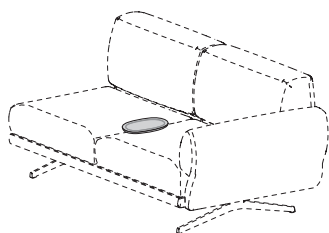

Posizionamenti possibili del tavolino Sofa table positioning options

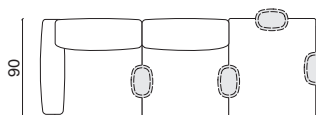
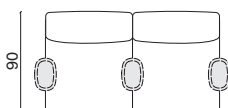
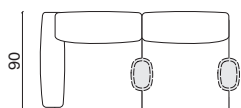

Piano Shelf

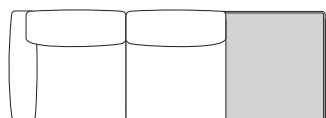
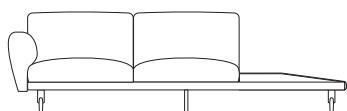

Piano legno: realizzati con pannelli spessore 2,2 cm.
Wooden shelf: made from 2,2 cm-thick chipboard panels.

Piano marmo: realizzati in spessore 2 cm in marmo o pietra lavica.
Marble shelf: 2 cm thick made from marble or lava stone.

Piano light stone: realizzati in spessore 0,6 cm in lastra di gres applicato su un pannello sp. 1,2 cm.
Light stone shelf: 0,6 cm thick made from sheet of light stone applied to 1,2cm-thick panel

Divano NOA / NOA sofa

COMPOSIZIONE 1 CONFIGURATION 1

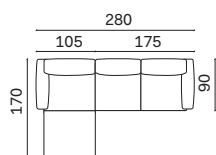

Larghezza Width	Profondità Depth	Altezza Height	Peso Weight
280 cm	170 cm	77 cm	150,3 kg

Composta da:

Comprising:

- 1 Penisola laterale 105x170 Sx
LH side chaise longue 105x170
- 1 Laterale 175 Dx
RH side 175

COMPOSIZIONE 2 CONFIGURATION 2

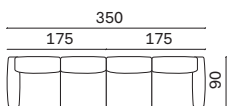

Larghezza Width	Profondità Depth	Altezza Height	Peso Weight
350 cm	90 cm	77 cm	153,5 kg

Composta da:

Comprising:

- 1 Laterale 175 Sx
LH side 175
- 1 Laterale 175 Dx
RH side 175

COMPOSIZIONE 3 CONFIGURATION 3

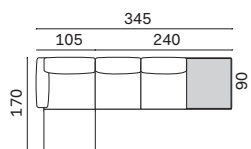

Larghezza Width	Profondità Depth	Altezza Height	Peso Weight
345 cm	170 cm	77 cm	162,9 kg

Composta da:

Comprising:

- 1 Penisola laterale 105x170 Sx
LH side chaise longue 105x170
- 1 Centrale 240 con 1 posto con piano
Central 240 with shelf in place of 1 seat

COMPOSIZIONE 4 CONFIGURATION 4

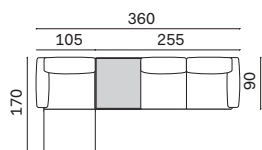

Larghezza Width	Profondità Depth	Altezza Height	Peso Weight
360 cm	170 cm	77 cm	171,8 kg

Composta da:

Comprising:

- 1 Penisola laterale 105x170 Sx
LH side chaise longue 105x170
- 1 Laterale 255 Dx con 1 posto con piano
RH side 255 with shelf in place of 1 seat

Divano NOA / NOA sofa

COMPOSIZIONE 5 CONFIGURATION 5

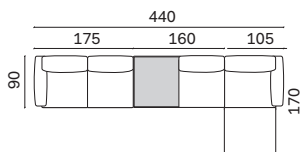

Larghezza Width	Profondità Depth	Altezza Height	Peso Weight
440 cm	170 cm	77 cm	215,5 kg

Composta da:

Comprising:

- 1 Laterale 175 Sx
LH side 175
- 1 Centrale 160 con 1 posto con piano
Central 160 with shelf in place of 1 seat
- 1 Penisola laterale 105x170 Dx
RH side chaise longue 105x170

COMPOSIZIONE 6 CONFIGURATION 6

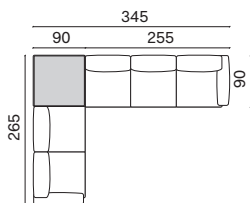
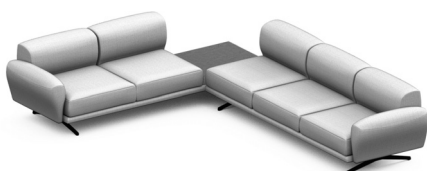

Larghezza Width	Profondità Depth	Altezza Height	Peso Weight
345 cm	265 cm	77 cm	201,5 kg

Composta da:

Comprising:

- 1 Angolo 265x90 Sx con posto angolo con piano
LH corner 265x90 with shelf in place of corner seat
- 1 Laterale 255 Dx
RH side 255

COMPOSIZIONE 7 CONFIGURATION 7

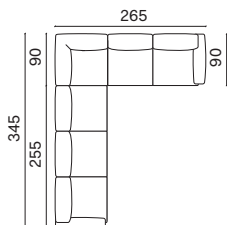

Larghezza Width	Profondità Depth	Altezza Height	Peso Weight
265 cm	345 cm	77 cm	210,2 kg

Composta da:

Comprising:

- 1 Laterale 255 Sx
LH side 255
- 1 Angolo 265x90 Dx
RH corner 265x90

COMPOSIZIONE 8 CONFIGURATION 8

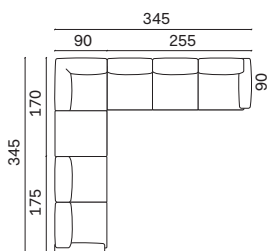

Larghezza Width	Profondità Depth	Altezza Height	Peso Weight
345 cm	345 cm	77 cm	247,5 kg

Composta da:

Comprising:

- 1 Laterale 175 Sx
LH side 175
- 1 Angolo 170x90 Sx con 1 posto senza schienale
LH corner 170x90 with 1 backless seat
- 1 Laterale 255 Dx
RH side 255

Divano NOA / NOA sofa

COMPOSIZIONE 9 CONFIGURATION 9

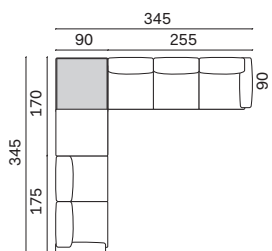
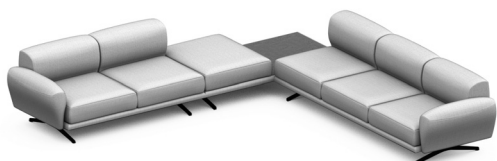

Larghezza Width	Profondità Depth	Altezza Height	Peso Weight
345 cm	345 cm	77 cm	238,8 kg

Composta da:

Comprising:

- 1 Laterale 175 Sx
LH side 175
- 1 Angolo 170x90 Sx con 1 posto senza schienale e posto angolo con piano
LH corner 170x90 with 1 backless seat and shelf in place of corner seat
- 1 Laterale 255 Dx
RH side 255

COMPOSIZIONE 10 CONFIGURATION 10

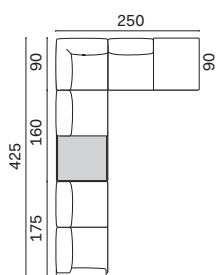

Larghezza Width	Profondità Depth	Altezza Height	Peso Weight
250 cm	425 cm	77 cm	236 cm

Composta da:

Comprising:

- 1 Laterale 175 Sx
LH side 175
- 1 Centrale 160 con 1 posto con piano
Corner 160 with shelf in place of 1 seat
- 1 Angolo 250x90 Dx con 1 posto senza schienale
RH corner 250x90 with 1 backless seat

Divano NOA / NOA sofa

CUSCINI OPZIONALI OPTIONAL CUSHIONS

Imbottitura in misto piuma. Cucitura pizzicata sui lati verticali.
Feather blend filling. Reverse-stitched seams on vertical sides.

Cuscino 45x45 Cushion 45x45



Larghezza	Altezza	Peso
Width	Height	Weight
<u>45 cm</u>	<u>45 cm</u>	<u>1,4 kg</u>

Cuscino 60x60 Cushion 60x60



Larghezza	Altezza	Peso
Width	Height	Weight
<u>60 cm</u>	<u>60 cm</u>	<u>1,8 kg</u>

Cuscino caramella 50x25 Rectangular cushion 50x25



Larghezza	Altezza	Peso
Width	Height	Weight
<u>50 cm</u>	<u>25 cm</u>	<u>1 kg</u>

Cuscino caramella 70x25 Rectangular cushion 70x25



Larghezza	Altezza	Peso
Width	Height	Weight
<u>70 cm</u>	<u>25 cm</u>	<u>1,6 kg</u>

Divano NOA / NOA sofa

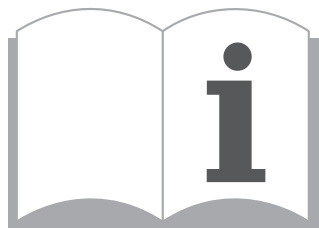

RIVESTIMENTI

COVERS

I colori dei tessuti e delle pelli possono variare di tonalità da una partita a l'altra e non è possibile, quindi, garantire la perfetta corrispondenza di colore sia rispetto al campionario sia rispetto ad elementi prodotti in tempi differenti. I colori dei campionari o altro supporto, sono pertanto da ritenersi indicativi. Il cliente, confermando l'ordine, accetta tali tolleranze.

Fabric and leather colours can vary in shade from one batch to the next and, consequently, we cannot guarantee that the colour will exactly match the set of fabric samples or pieces manufactured at a later date. Please understand, therefore, that colours on fabric samples or other media are given as a rough guide only. By confirming the order, the customer accepts said tolerances.

COORDINAMENTO RIVESTIMENTI

COVER COORDINATION

Si prega di notare che per i cuscini di schienale, seduta e scocca è previsto l'uso di un unico tessuto/pelle. Non sono possibili combinazioni miste, salvo dove specificato.

Please note that backrest, seat and carcass cushions must all be covered in the same choice of fabric/leather. Mixed combinations are not possible unless otherwise specified.

MISURE

MEASUREMENTS

Viste le caratteristiche tecniche del prodotto imbottito, le misure di ingombro, indicate a listino, possono avere una tolleranza compresa tra +/- 2 cm.

Given the technical properties of the sofa/ottoman and cushions, overall measurements given on the price list may have a tolerance of +/- 2 cm.

FUORI MISURA

CUSTOM SIZES

Non si eseguono riduzioni a misura di nessun tipo.

We cannot produce custom sizes of any kind.

BRACCIOLI DX E SX

RH AND LH ARMRESTS

Nelle composizioni angolari la posizione dei braccioli (dx o sx) va intesa guardando il divano di fronte.

In corner configurations, note that the position of the armrests (RH or LH) is as viewed from in front of the sofa.

TESSUTO CLIENTE

CUSTOMER'S FABRIC

Il tessuto fornito dal cliente deve essere H. 1,40 e reso alla ditta franco da ogni spesa. Sul tessuto dovrà essere indicato chiaramente il lato dritto e rovescio. Nel caso di tessuti non tinta unita considerare un metraggio maggiorato del 15%. Nessuna contestazione potrà essere mossa per motivi tecnici/estetici per prodotti con tessuti forniti dal cliente.

Fabric supplied by the customer must be 1,40 cm high and sent to us free of charges. The right side and wrong side must be clearly marked on the fabric. Bear in mind that the amount of fabric required when dealing with anything other than plain colours increases by 15%. We cannot accept complaints made about technical/aesthetic results for products made with fabrics supplied by the customer.

NOTE SULLA SPEDIZIONE DEI TESSUTI

NOTES ON SENDING FABRICS

Tagli di tessuto o fodere di ricambio possono essere spediti a mezzo corriere espresso con addebito forfettario di €50 (netto).

Lengths of fabric or spare covers can be express couriered at a (net) flat rate of €50.