



Ampi e comodi volumi rettangolari caratterizzano il divano Mac. La modularità degli elementi e le numerose profondità delle sedute consentono di disegnare un angolo di serenità e di quiete che asseconda le diverse esigenze di stile e di spazio.

Generous, comfortable rectangular forms are the distinguishing traits of the Mac sofa. The modularity of its sections and the numerous seat depths allow you to carve out a corner of peace and quiet that meets a whole range of different style and space requirements.

Divano MAC / MAC sofa



RIVESTIMENTO COVERS

Rivestimento completamente sfoderabile in tessuto, in pelle è fisso.
Fabric covers are fully removable, leather version has fixed covers.

MODULARITÀ MODULE SIZES

Vista laterale Side view

con cuscino schienale
with backrest cushion

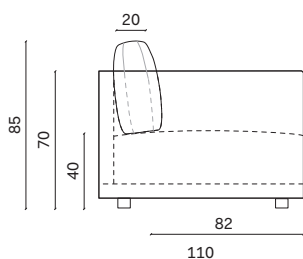
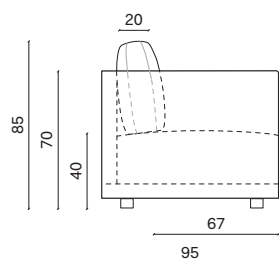

con 2 cuscini a saponetta
with 2 pillow-shaped cushions

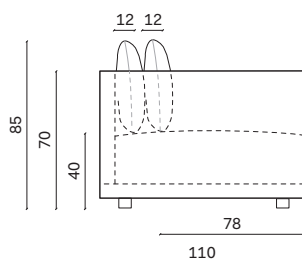

Vista frontale Front view

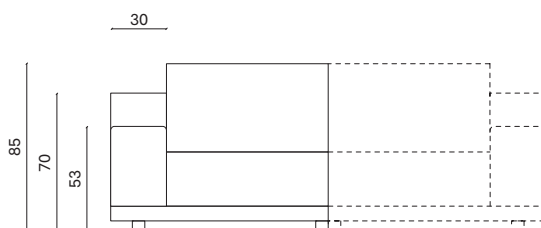
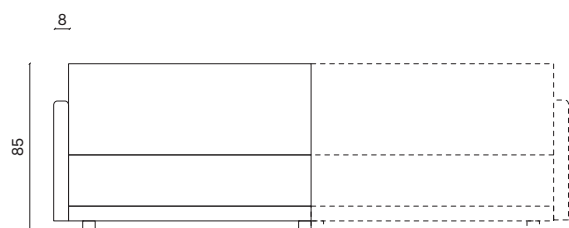

Divano MAC / MAC sofa

ELEMENTI CENTRALI CENTRAL SECTIONS

P./D 95

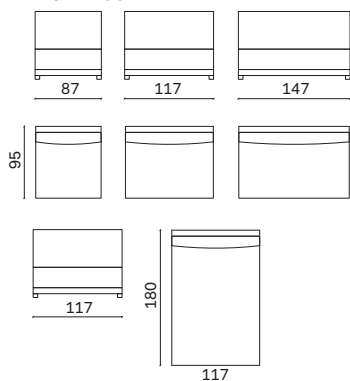

P./D 110

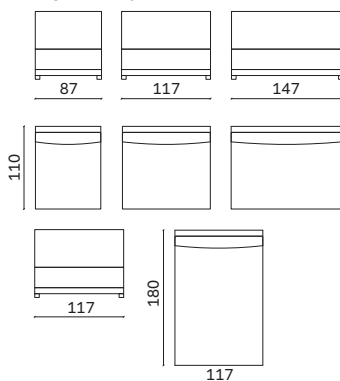

P./D 110

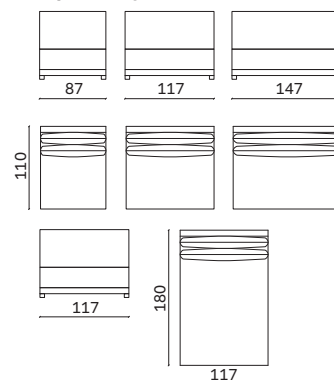

ELEMENTI LATERALI SX - DX CON BRACCIOLO LARGH. 8 CM LH - RH SIDE SECTIONS WITH 8CM-WIDE ARMREST

P./D 95

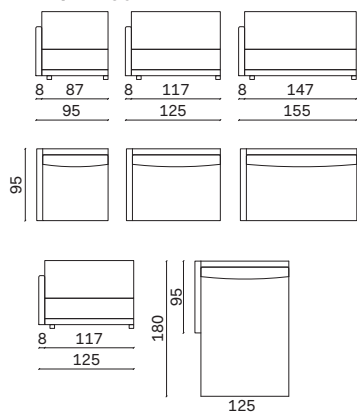

P./D 110

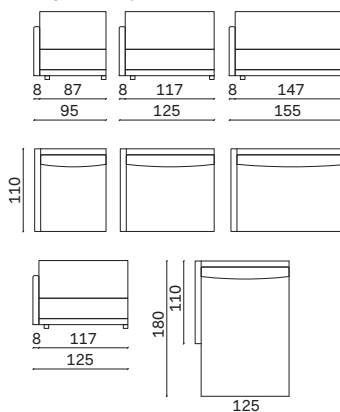

P./D 110

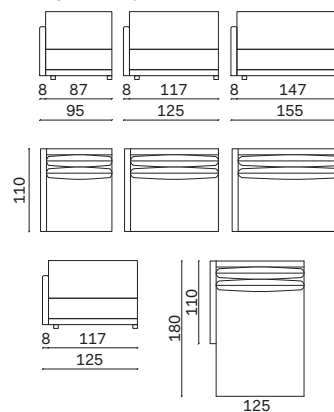

ELEMENTI CON BRACCIOLO LARGH. 30 CM SECTIONS WITH 30CM-WIDE ARMREST

P./D 95

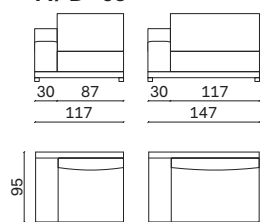

P./D 110

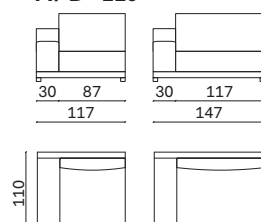

P./D 110

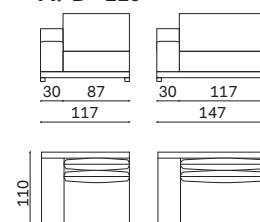

ELEMENTI ANGOLO E POUF CORNER SECTIONS AND OTTOMANS

P./D 95

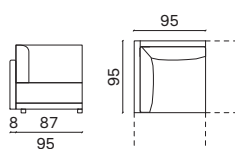

P./D 110

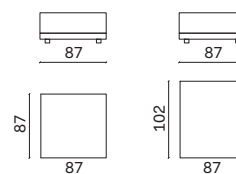
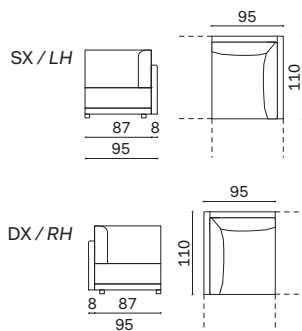

NOVAMOBILI

Divano MAC / MAC sofa

COMPOSIZIONE 1 CONFIGURATION 1

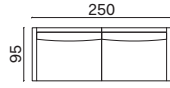

Larghezza Width	Profondità Depth	Altezza Height	Peso Weight
250 cm	95 cm	85 cm	96,4 kg

Composta da:

Comprising:

- 1 Laterale 125 Sx prof. 95 cm
LH side 125 95 cm deep
- 1 Laterale 125 Dx prof. 95 cm
RH side 125 95 cm deep

COMPOSIZIONE 2 CONFIGURATION 2

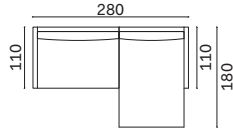

Larghezza Width	Profondità Depth	Altezza Height	Peso Weight
280 cm	110/180 cm	85 cm	142,2 kg

Composta da:

Comprising:

- 1 Laterale 155 Sx prof. 110 cm
LH side 155 110 cm deep
- 1 Penisola laterale 125x180 Dx e bracciolo prof. 110 cm
RH chaise 125x180 and arm 110 cm deep

COMPOSIZIONE 3 CONFIGURATION 3

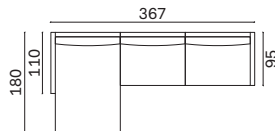

Larghezza Width	Profondità Depth	Altezza Height	Peso Weight
367 cm	110/180/95 cm	85 cm	165,2 kg

Composta da:

Comprising:

- 1 Penisola laterale 125x180 Sx e bracciolo prof. 110 cm
LH chaise 125x180 and arm 110 cm deep
- 1 Centrale 117 prof. 95 cm
Central 117 95 cm deep
- 1 Laterale 125 Dx prof. 95 cm
RH side 125 95 cm deep

COMPOSIZIONE 4 CONFIGURATION 4

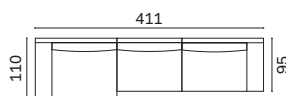

Larghezza Width	Profondità Depth	Altezza Height	Peso Weight
411 cm	110 cm	85 cm	188,1 kg

Composta da:

Comprising:

- 1 Elemento 147 con bracciolo L. 30 cm e 1 cuscino prof. 110 cm
Section 147 with armrest W 30 cm and 1 cushion 110 cm deep
- 1 Centrale 117 prof. 95 cm
Central 117 95 cm deep
- 1 Elemento 147 con bracciolo L. 30 cm prof. 95 cm
Section 147 with armrest W 30 cm 95 cm deep

Divano MAC / MAC sofa

COMPOSIZIONE 5 CONFIGURATION 5



Larghezza Width	Profondità Depth	Altezza Height	Peso Weight
454 cm	95/180 cm	85 cm	195,2 kg

Composta da:

Comprising:

- 1 Laterale 125 Sx prof. 95 cm
LH side 125 95 cm deep
- 1 Centrale 117 prof. 95 cm
Central 117 95 cm deep
- 1 Pouf 87x87
Ottoman 87x87
- 1 Penisola laterale 125x180 Dx con bracciolo prof. 95 cm
RH chaise 125x180 with arm 95 cm deep

COMPOSIZIONE 6 CONFIGURATION 6



Larghezza Width	Profondità Depth	Altezza Height	Peso Weight
397 cm	235 cm	85 cm	210,5 kg

Composta da:

Comprising:

- 1 Laterale 155 Sx con 2 cuscini a saponetta prof. 110 cm
LH side 155 with 2 pillow-shaped cushions 110 cm deep
- 1 Centrale 147 con 2 cuscini a saponetta prof. 110 cm
Central 147 with 2 pillow-shaped cushions 110 cm deep
- 1 Laterale 95 Dx con 2 cuscini a saponetta prof. 110 cm
RH side 95 with 2 pillow-shaped cushions 110 cm deep
- 1 Laterale 125 Dx prof. 95 cm
RH side 125 95 cm deep

COMPOSIZIONE 7 CONFIGURATION 7



Larghezza Width	Profondità Depth	Altezza Height	Peso Weight
359 cm	242 cm	85 cm	220,1 kg

Composta da:

Comprising:

- 1 Elemento 147 con bracciolo L. 30 cm prof. 95 cm
Section 147 with armrest W 30 cm 95 cm deep
- 1 Angolo 95x95 cm
95x95 cm corner
- 1 Centrale 117 prof. 95 cm
Central 117 95 cm deep
- 1 Elemento 147 con bracciolo L. 30 cm prof. 95 cm
Section 147 with armrest W 30 cm 95 cm deep

Divano MAC / MAC sofa

CUSCINI OPZIONALI OPTIONAL CUSHIONS

Imbottitura in misto piuma. Cucitura pizzicata sui lati verticali.
Feather blend filling. Reverse-stitched seams on vertical sides.

Cuscino 45x45 Cushion 45x45



Larghezza	Altezza	Peso
<i>Width</i>	<i>Height</i>	<i>Weight</i>
45 cm	45 cm	1,4 kg

Cuscino 60x60 Cushion 60x60



Larghezza	Altezza	Peso
<i>Width</i>	<i>Height</i>	<i>Weight</i>
60 cm	60 cm	1,8 kg

Cuscino caramella 50x25 Rectangular cushion 50x25



Larghezza	Altezza	Peso
<i>Width</i>	<i>Height</i>	<i>Weight</i>
50 cm	25 cm	1 kg

Cuscino caramella 70x25 Rectangular cushion 70x25



Larghezza	Altezza	Peso
<i>Width</i>	<i>Height</i>	<i>Weight</i>
70 cm	25 cm	1,6 kg

Divano MAC / MAC sofa

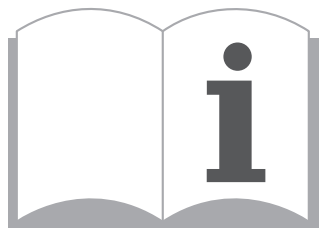

RIVESTIMENTI

COVERS

I colori dei tessuti e delle pelli possono variare di tonalità da una partita a l'altra e non è possibile, quindi, garantire la perfetta corrispondenza di colore sia rispetto al campionario sia rispetto ad elementi prodotti in tempi differenti. I colori dei campionari o altro supporto, sono pertanto da ritenersi indicativi. Il cliente, confermando l'ordine, accetta tali tolleranze.

Fabric and leather colours can vary in shade from one batch to the next and, consequently, we cannot guarantee that the colour will exactly match the set of fabric samples or pieces manufactured at a later date. Please understand, therefore, that colours on fabric samples or other media are given as a rough guide only. By confirming the order, the customer accepts said tolerances.

COORDINAMENTO RIVESTIMENTI

COVER COORDINATION

Si prega di notare che per i cuscini di schienale, seduta e scocca è previsto l'uso di un unico tessuto/pelle. Non sono possibili combinazioni miste, salvo dove specificato.

Please note that backrest, seat and carcass cushions must all be covered in the same choice of fabric/leather. Mixed combinations are not possible unless otherwise specified.

MISURE

MEASUREMENTS

Viste le caratteristiche tecniche del prodotto imbottito, le misure di ingombro, indicate a listino, possono avere una tolleranza compresa tra +/- 2 cm.

Given the technical properties of the sofa/ottoman and cushions, overall measurements given on the price list may have a tolerance of +/- 2 cm.

FUORI MISURA

CUSTOM SIZES

Non si eseguono riduzioni a misura di nessun tipo.

We cannot produce custom sizes of any kind.

BRACCIOLI DX E SX

RH AND LH ARMRESTS

Nelle composizioni angolari la posizione dei braccioli (dx o sx) va intesa guardando il divano di fronte.

In corner configurations, note that the position of the armrests (RH or LH) is as viewed from in front of the sofa.

TESSUTO CLIENTE

CUSTOMER'S FABRIC

Il tessuto fornito dal cliente deve essere H. 1,40 e reso alla ditta franco da ogni spesa. Sul tessuto dovrà essere indicato chiaramente il lato dritto e rovescio. Nel caso di tessuti non tinta unita considerare un metraggio maggiorato del 15%. Nessuna contestazione potrà essere mossa per motivi tecnici/estetici per prodotti con tessuti forniti dal cliente.

Fabric supplied by the customer must be 1,40 cm high and sent to us free of charges. The right side and wrong side must be clearly marked on the fabric. Bear in mind that the amount of fabric required when dealing with anything other than plain colours increases by 15%. We cannot accept complaints made about technical/aesthetic results for products made with fabrics supplied by the customer.

NOTE SULLA SPEDIZIONE DEI TESSUTI

NOTES ON SENDING FABRICS

Tagli di tessuto o fodere di ricambio possono essere spediti a mezzo corriere espresso con addebito forfettario di €50 (netto).

Lengths of fabric or spare covers can be express couriered at a (net) flat rate of €50.