

BREAK walk-in closet

INFORMAZIONI TECNICHE
TECHNICAL INFORMATION

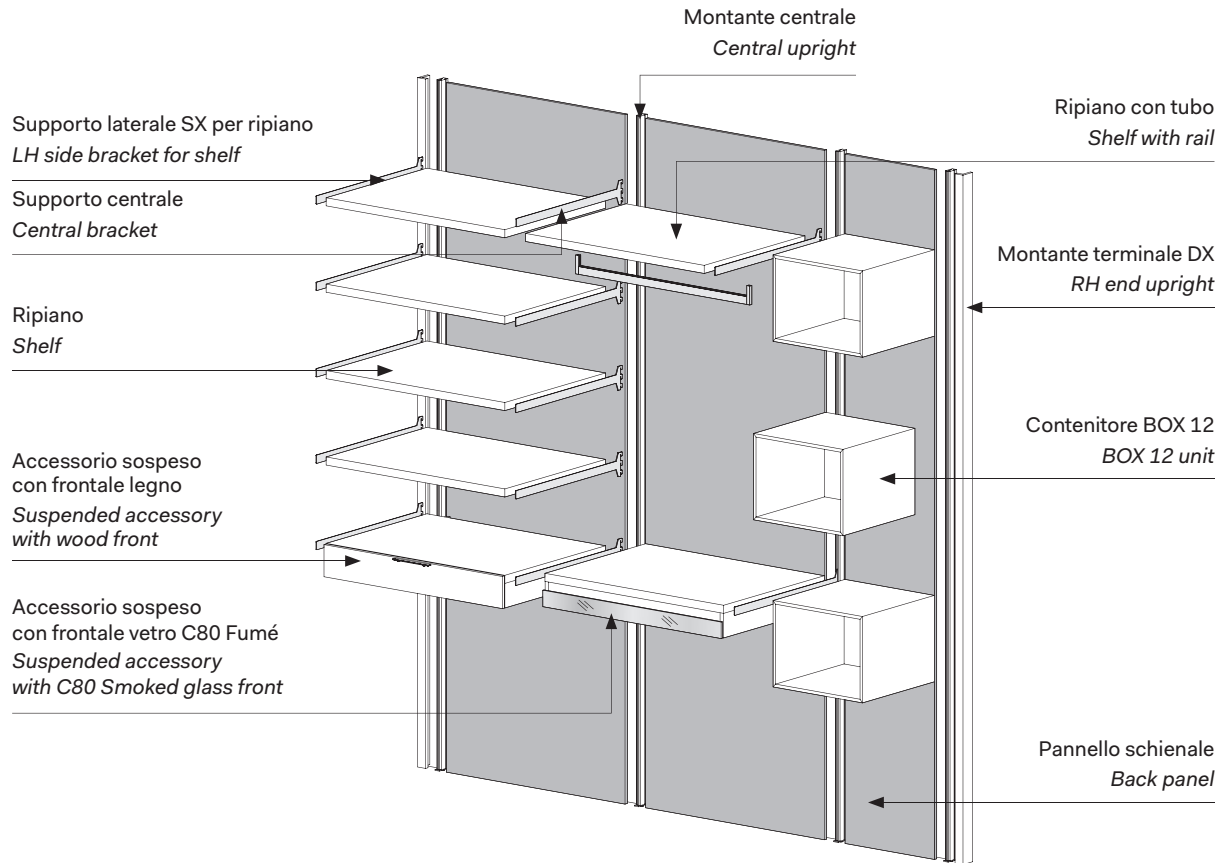

BREAK walk-in closet

ALTEZZA E LARGHEZZA HEIGHTS AND WIDTHS

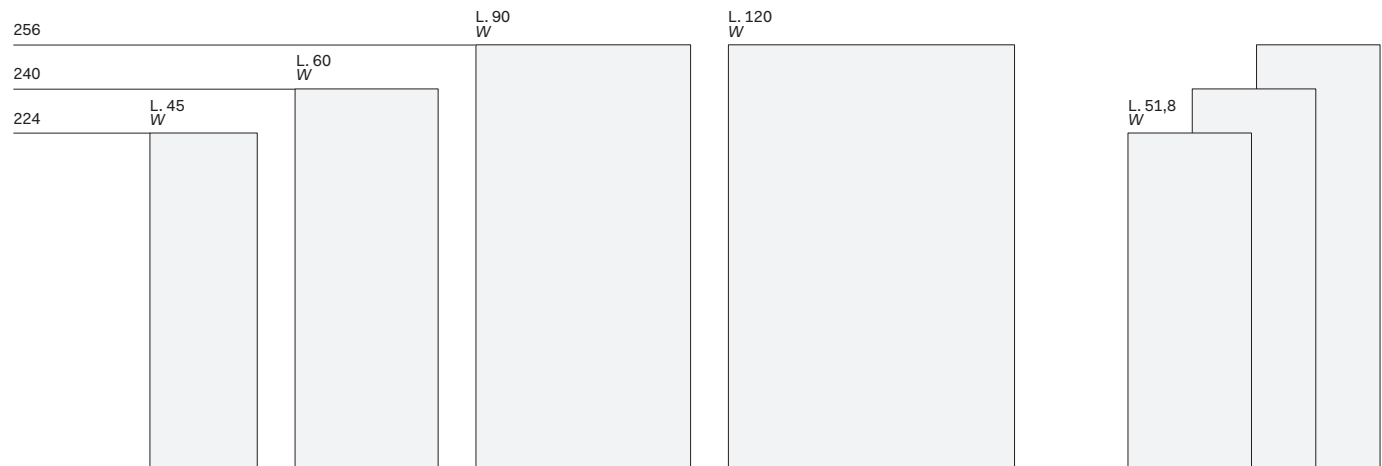

PROFONDITÀ DEPTHS

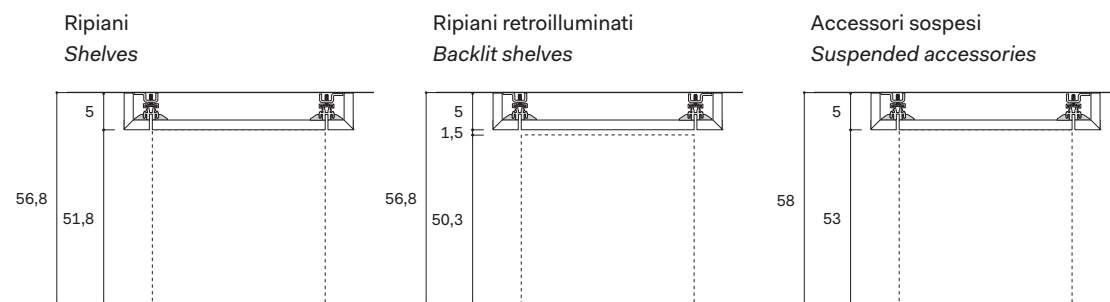

Distanza del pannello dal muro Distance of panel from wall

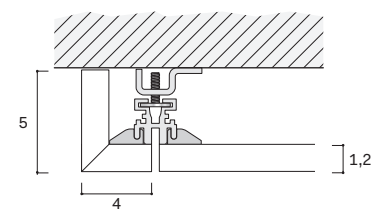

Distanza del pannello con specchio dal muro Distance of panel with mirror from wall

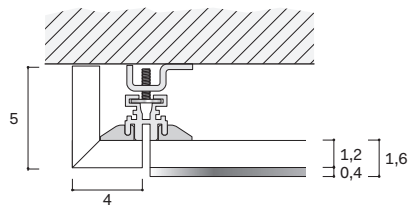

ANGOLO CORNER

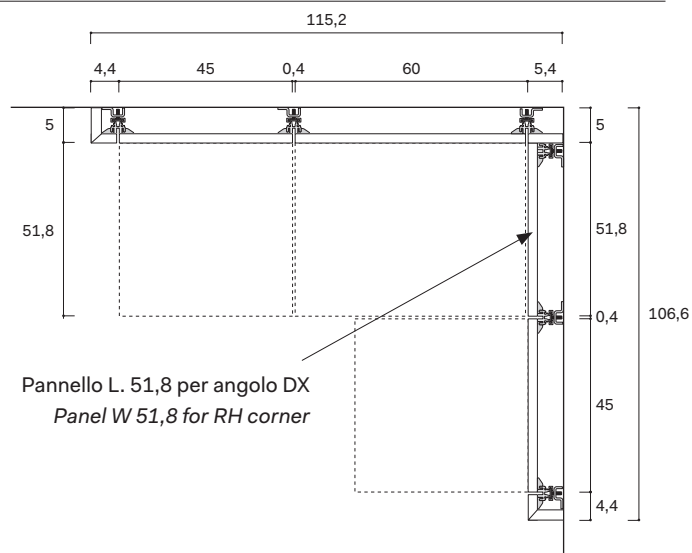

BREAK walk-in closet

UTILIZZO PANNELLI LINEARI
USE OF LINEAR PANELS

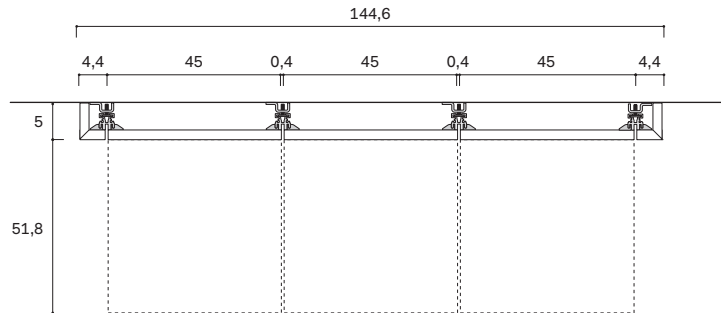

ESEMPIO COMPOSIZIONI A "U"
EXAMPLES OF U-SHAPED CONFIGURATIONS

Esempio 1
Example 1

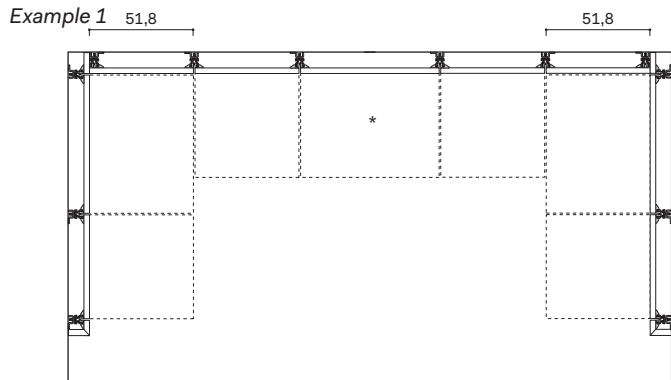

Esempio 2
Example 2

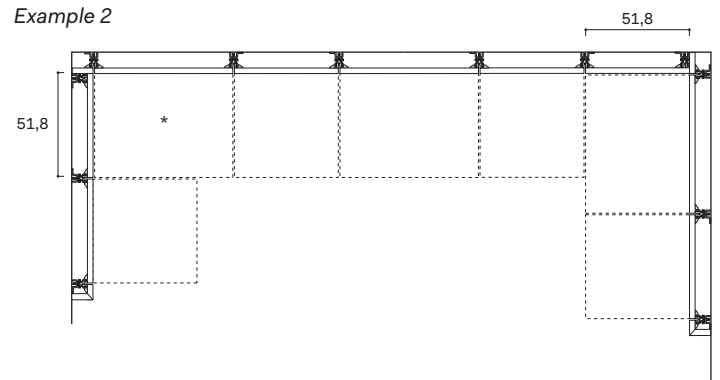

Esempio 3
Example 3

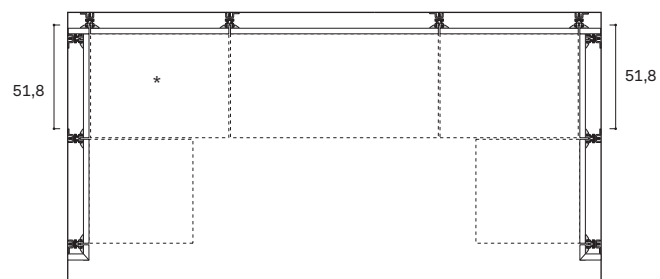

Esempio 4
Example 4

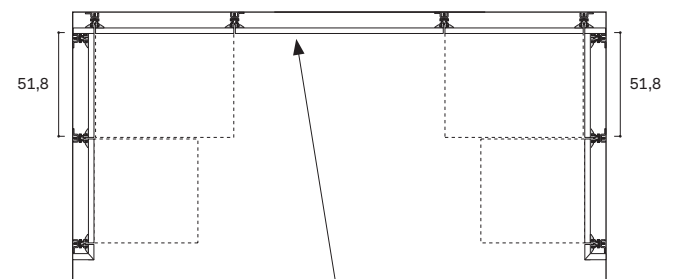

Sequenza ripiani interrotta
(o sfalsata)
Break in run of shelves
(or offset shelves)

BREAK walk-in closet

ACCESSORI CABINA BREAK
BREAK WALK-IN CLOSETS ACCESSORIES

TUBI APPENDIABILI PLUS
PLUS HANGING RAILS

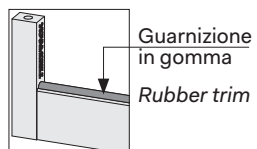

misure L x H x P cm /
dimensions W x H x D cm

45 / 60 / 90 / 120 x 3 x 1,5

APPENDIABILI SERVETTO
CLOTHES LIFT

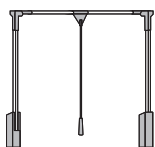

misure /
dimensions

Largh. da 90 a 120
Width from 90 to 120

SUPPORTO PER SERVETTO
BRACKET FOR CLOTHES LIFT

